

Designing & Creating



2019
PRODUCT
CATALOGUE

BUTKON[®]
www.butkon.com



index

Kurumsal Corporate	2-3
Üretim Production	4-5
Kalite Politikası Quality Policy	4-5
Truva Serisi Truva Series	6-7
Standart Serisi Standart Series	8-9
Yakamoz Serisi Yakamoz Series	10-11
Işıklı Sıva Üstü Kabin Panelleri Stainless Lighted Cabin Panels	12
Yatay Kabin Panelleri Horizontal Panels	13
Sıva Altı Kabin Panelleri Flush Mount Stainless Cabin Panels	14
Sıva Altı Kat Panelleri Flush Mount Stainless Floor Panels	15
Standart Zamak Serisi Standart Zamak Series	16
İnce Zamak Serisi Slime Zamak Series	17
Kapı Üstü Göstergeler Door Top Indicators	18
Sıva Üstü Kat Panelleri Stainless Surface Mounted Floor Panels	19
Dokunmatik Kabin Panelleri Touch Cabin Panels	20
Dokunmatik Kat Panelleri Touch Floor Panels	21
Butonlu Cam ve Pleksiglas Kabin Panelleri Glass Panels and Plexiglass Cabin Panels	22
Butonlu Cam ve Pleksiglas Kat Panelleri Glass Panels and Plexiglass Floor Panels	23
Butcode ve Buthazır Butcode and Buthazır	24-25
Pradas Pradas	26-27
Diğer Ekipmanlar Other Equipments	28-29
Özel koleksiyon Private Collection	30
Hazır Tesisatlar Dimensions	31
Ölçüler Dimensions	32-33

Designing & Creating

Ürettiğimiz bütün elektronik kartların AR-GE çalışmaları elektronik mühendislerimiz tarafından, testleri kalite onay sürecinden geçerek hassas kart dizgi makinelerimizde seri üretimleri yapılmaktadır.

Our all electronic cards that we produce have been checked by our electronic engineers during the research and development process. After that, we do serial production by our precision card sorting machines.

BUTKON
www.butkon.com





Şirketimiz Hakkında

2007 yılında kurulan Butkon Asansör San. Tic. Ltd. Şti. Asansör kat ve kabin panelleri üretimi yapmaktadır.

Sektörde 10 yılı aşkın iş tecrübesi bulunan firmamız, 3000m² kapalı alanında 4 Mühendis, 70 çalışanı ile müşterilerine kaliteli ve düşük maliyetli ürünleri sunmak için çalışmalarına devam etmektedir.

Sürekli gelişme çabası içinde olan Butkon, elektronik kartlarını üretmek için dizgi makinesi, butonların plastik aksamalarını üretmek için plastik enjeksiyon makinelerini, paslanmaz sac işlemek için abkant pres makas ve eksantirik hidrolik pres makinelerini bünyesinde bulundurarak uzman ekibiyle, gerek yurtiçi gerekse yurtdışı piyasasında marka haline gelmiştir.

Butkon, satış sonrası hizmetlerini de geliştirerek müşteri memnuniyetini ön planda tutmuştur.

About Our Company

Butkon Asansör San. Tic. Ltd. Corp., which was established in 2007, is producing elevator floor and cabin panels.

Our company having a business experience over 10 years in the industry, is continuing to work in order to offer high quality and low cost products to its customers with 4 Engineers, 70 employees in a 3000m² indoor area.

Butkon, which is in a continuous development effort, has become a brand in both domestic and foreign markets with its expert team by keeping typesetting machine to produce electronic cards, plastic injection machines to produce plastic components of buttons, press brake scissors and eccentric hydraulic press machines to process stainless steel sheets.

Butkon has kept the customer satisfaction at the forefront by improving the aftersales services.

نبذة عنا

تأسست شركة بوتكون للمصاعد والصناعة والتجارة المحدودة في عام 2007 لتقوم بإنتاج الواح وكابينات المصاعد.

تمتلك شركتنا خبرة مهنية لأكثر من 10 سنوات في قطاع إنتاج المصاعد وتواصل أعمالها الإنتاجية في مصنع بمساحة مغلقة تبلغ 3000 متر مربع مع 4 مهندسين خبراء و 70 عامل بهدف تقديم خدمات ومنتجات عالية الجودة ومنخفضة التكاليف إلى عملائها.

تسعى بوتكون إلى تطوير نفسها باستمرار واحتلال مكانة رائدة في السوق المحلية والدولية فهي تملك مكانن إنتاجية ذات تقنيات عالية, حيث يتم إنتاج البطاقات الإلكترونية بمكانن مطبعية, وإنتاج الاجزاء البلاستيكية للازرار بمكانن حقن البلاستيك, اما إنتاج الاجزاء المعدنية من السيتيل فتستخدم مكانن الضغط الهيدروليكية الاستثنائية والمقصات الخاصة, وتتوفر هذه المكانن ضمن بنية الشركة مع فريق عمل خبير ومتخصص.

كما تحافظ بوتكون على رضا العملاء في مستويات عالية في الخدمات التي تعقب عمليات البيع.



SIVA ÜSTÜ KABİN PANELLERİ
Surface Mount Stainless Cabin Panels
لوحة طلب داخلي ستانلس ستيل

SIVA ÜSTÜ KAT PANELLERİ
Surface Mount Stainless Floor Panels
الواح طوابق فوق اللياسة من الفولاذ المقاوم للصدأ

U21TM0006
(Truva Boy Kabin)



U21TM0006



U21YR0005



U21YR0005
(Truva Yarım Boy Kabin)



	En / Width	Boy / Height	Derinlik / Deph
U21TM0006	200 mm	2000 mm	20 mm
U21YR0005	200 mm	1000 mm	20 mm

U20SM0017
(Truva Çift Düğme)



U20SM0014
(Truva Düz Kablosuz)



U20SM0010
(Truva Kablotlu)



U20KU0004
(Truva K.Ü. Gösterge)



U20SM0010

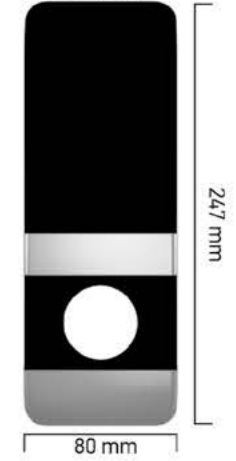

U20DJ0008
Truva Dijitalsiz
Çift Düğme



U20DJ0009
Truva Dijitalsiz
Tek Düğme



	En / Width	Boy / Height	Derinlik / Deph
U20SM0010	85 mm	247 mm	14 mm
U20SM0014	85 mm	247 mm	14 mm
U20SM0017	85 mm	277 mm	14 mm
U20KU0004	75 mm	230 mm	45 mm
U20DJ0008	85 mm	200 mm	14 mm
U20DJ0009	85 mm	200 mm	14 mm

U21TM0002
(Tam Boy Kabin - SÜ)

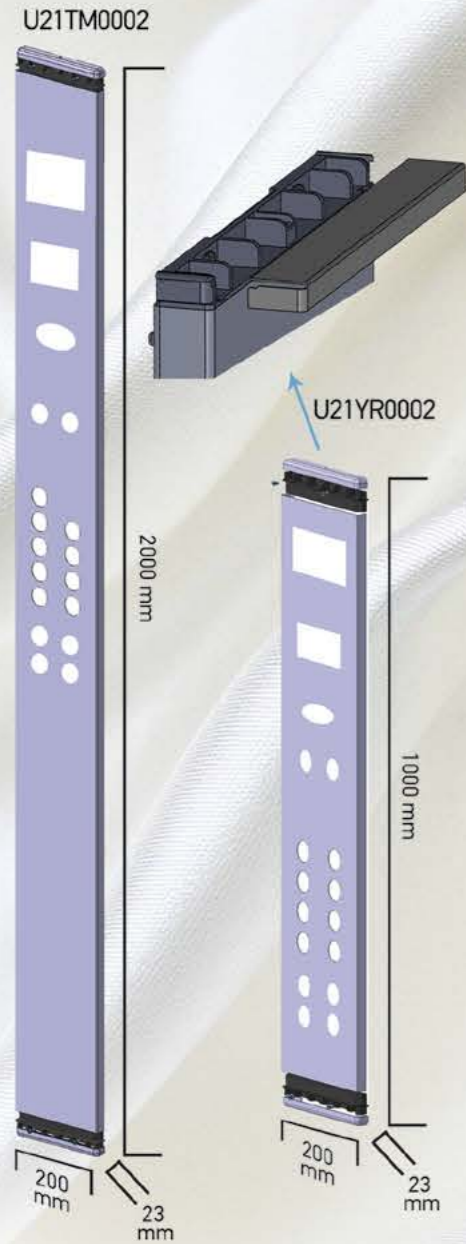

	En / Width	Boy / Height	Derinlik / Deph
U21TM0002	200 mm	2000mm	23 mm
U21YR0002	200 mm	1000mm	23 mm



U21YR0002
(Yarım Boy Kabin - SÜ)



U20KU0001
(Yeni Seri KÜ Gösterge)



U20SM0007
(Yeni Seri)



U20DB0005
(Dubleks Çift Buton Yan Yana)



U20DB0004
(Dubleks Tek Buton)



U20DJ0004
(Dijitalsiz Tek Buton -SÜ)



U20DJ0005
(Dijitalsiz Çift Buton -SÜ)

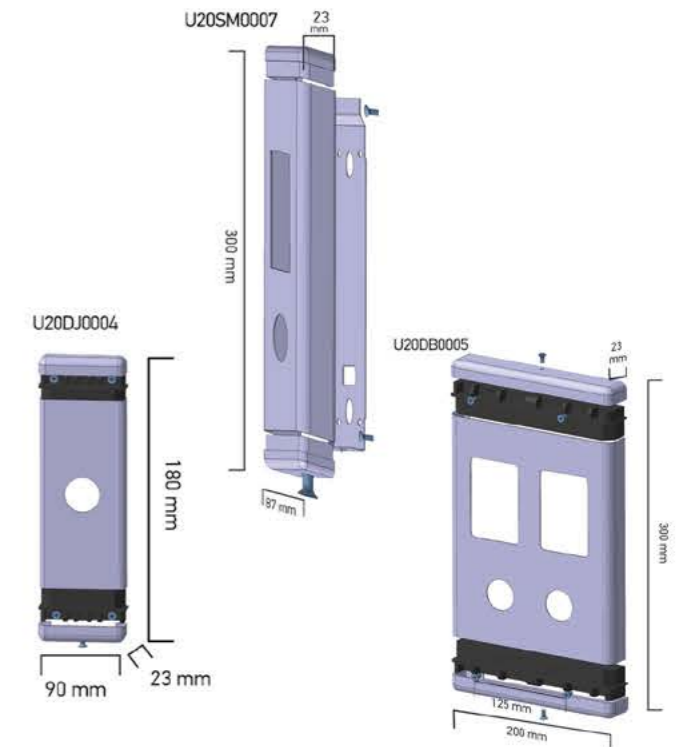

	En / Width	Boy / Height	Derinlik / Deph
U20DJ0004	90 mm	180 mm	23 mm
U20DJ0005	90 mm	180 mm	23 mm
U20KU0001	90 mm	240 mm	23 mm
U20SM0007	87 mm	300 mm	23 mm
U20DB0005	200 mm	300 mm	23 mm
U20DB0004	200 mm	300 mm	23 mm

SIVA ÜSTÜ KABİN PANELLERİ
Surface Mount Stainless Cabin Panels
لوحة طلب داخلي ستانلس ستيل

SIVA ÜSTÜ KAT PANELLERİ
Surface Mount Stainless Floor Panels
الواح طوابق فوق اللياسة من الفولاذ المقاوم للصدأ

U21TM0001
(Yakamoz Boy Kabin - SÜ)



U21YR0001
(Yakamoz Yarım Boy Kabin - SÜ)

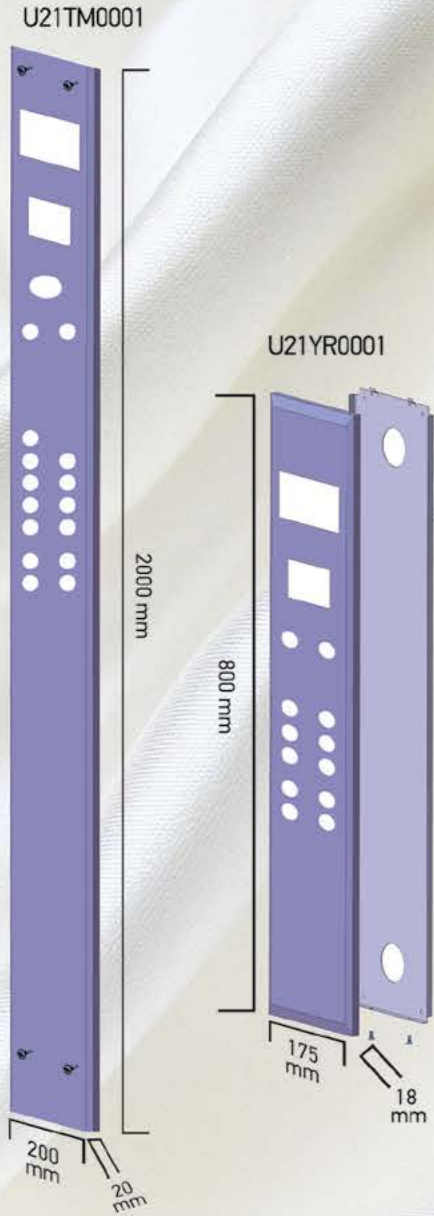

	En / Width	Boy / Height	Derinlik / Deph
U21TM0001	200 mm	2000 mm	20 mm
U21YR0001	175 mm	800 mm	18 mm



U20SM0002 **U20SM0016**
(Yakamoz Düz Kablosuz) (Yakamoz Çift Düğme)



Wired
سلكي **U20SM0001**
(Yakamoz Kablolu)

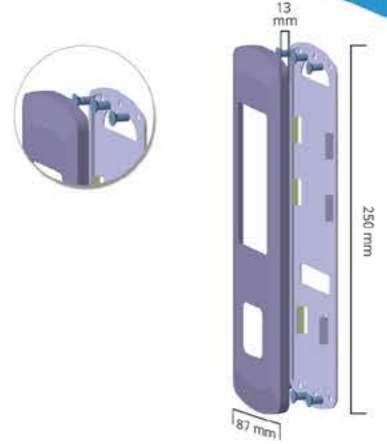

U20DB0002
(Yakamoz Dupleks Çift Buton Yan Yana)



U20DB0001
(Yakamoz Dupleks Tek Buton)



	En / Width	Boy / Height	Derinlik / Deph
U20SM0001	87 mm	250 mm	13 mm
U20SM0002	87 mm	250 mm	13 mm
U20SM0016	87 mm	250 mm	13 mm

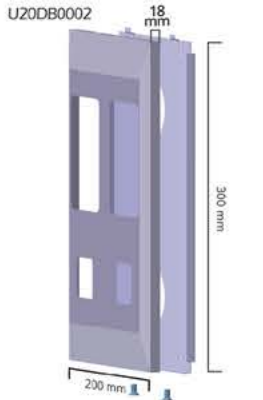

	En / Width	Boy / Height	Derinlik / Deph
U20DB0001	200 mm	300 mm	18 mm
U20DB0002	200 mm	300 mm	18 mm

U20DJ0001 **U20DJ0002** **U20DJ0003**
(Yakamoz Dijitalsiz Tek Buton - SÜ) (Yakamoz Dijitalsiz Çift Buton - SÜ) (Yakamoz Dijitalsiz Özel Buton - SÜ)



	En / Width	Boy / Height	Derinlik / Deph
U20DJ0001	87 mm	250 mm	13 mm
U20DJ0002	87 mm	250 mm	13 mm
U20DJ0003	87 mm	250 mm	13 mm

İŞIKLI SIVA ÜSTÜ KABİN PANELLERİ
Stainless Lighted Cabin Panels
لوحة طلب داخلي ستانلس ستيل مع إنارة

U21TM0003
(Işıklı Tam Boy Kabin)



U21TM0004
(Işıklı Tam Boy Kabin)

U21YR0003
(Işıklı Yarım Boy Kabin)

YATAY KABİN PANELLERİ
Horizontal panels
لوحات أفقية للمعاقين



U21YT0001
(Engelli Kabin)

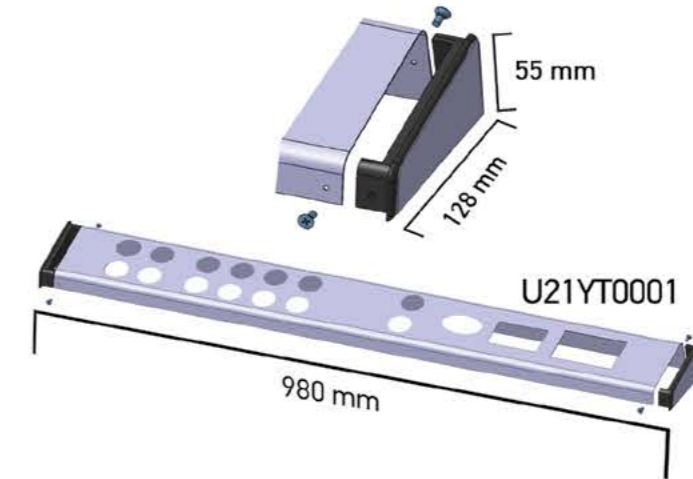

	En / Width	Boy / Height	Derinlik / Deph
U21YT0001	980 mm	128 mm	55 mm

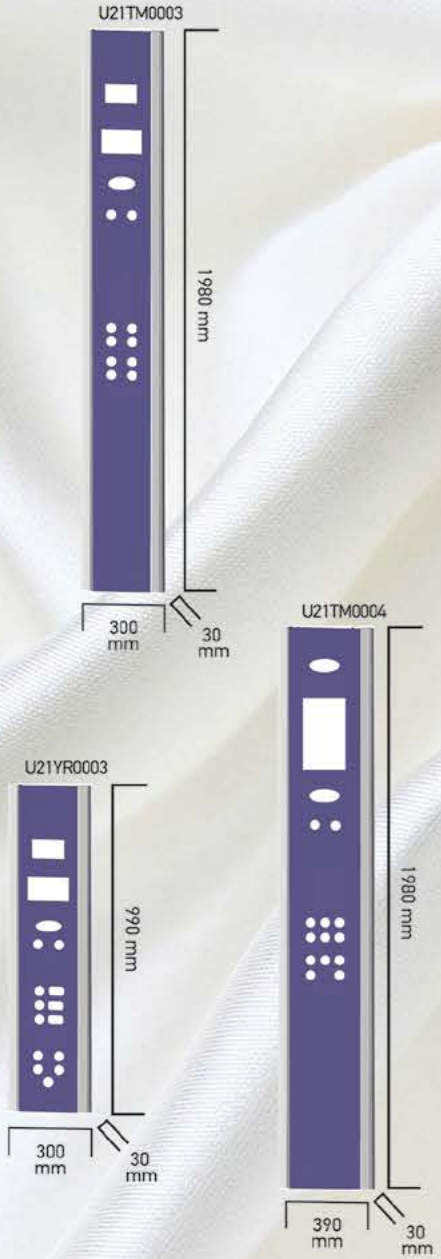

	En / Width	Boy / Height	Derinlik / Deph
U21TM0003	300 mm	1980 mm	30 mm
U21YR0003	300 mm	990 mm	30 mm
U21TM0004	390 mm	1980 mm	30 mm

SIVA ALTI KABİN PANELLERİ
Flush Mount Stainless Cabin Panels
لوحة طلب داخلي ستانلس ستيل مع علبة

SIVA ALTI KAT PANELLERİ
Flush Mount Stainless Floor Panels
لوحة طلب خارجي مع علبة

Designing & Creating

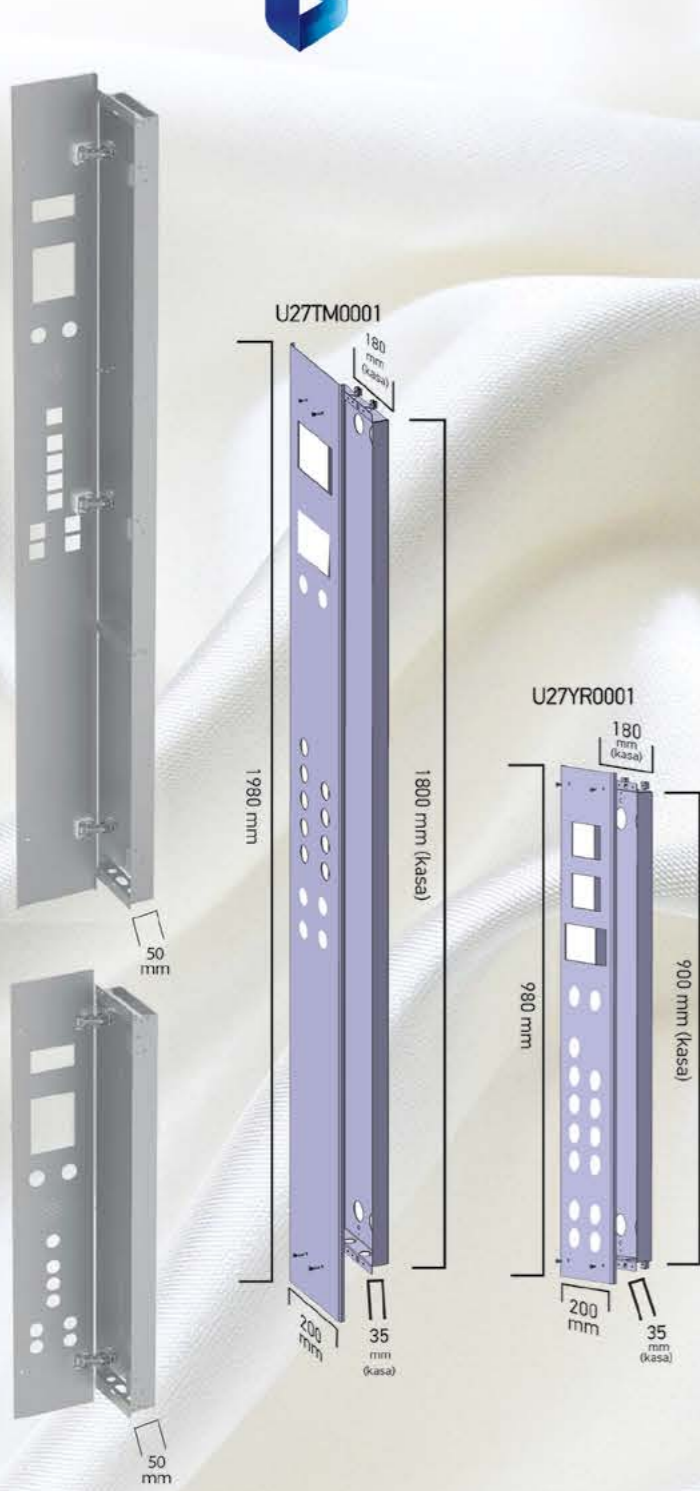

U27TM0001	En / Width	Boy / Height	Derinlik / Depth
KAPAK	200 mm	1980 mm	14 mm
KASA	180 mm	1800 mm	35 mm
U27YR0001	En / Width	Boy / Height	Derinlik / Depth
KAPAK	200 mm	980 mm	14 mm
KASA	180 mm	800 mm	35 mm

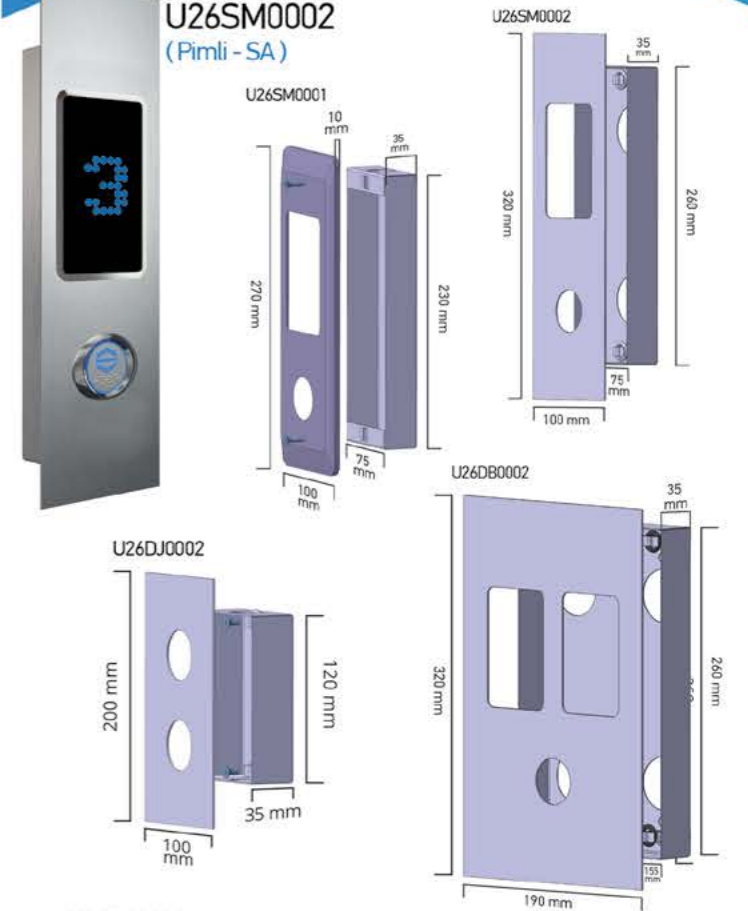

U26DJ0001	En / Width	Boy / Height	Derinlik / Depth
KAPAK	100 mm	200 mm	1,5 mm
KASA	75 mm	120 mm	35 mm
U26SM0001	En / Width	Boy / Height	Derinlik / Depth
KAPAK	100 mm	270 mm	10 mm
KASA	75 mm	230 mm	35 mm
U26SM0002	En / Width	Boy / Height	Derinlik / Depth
KAPAK	100 mm	320 mm	1,5 mm
KASA	75 mm	260 mm	35 mm
U26DB0001	En / Width	Boy / Height	Derinlik / Depth
KAPAK	190 mm	320 mm	1,5 mm
KASA	155 mm	260 mm	35 mm
U26DB0002	En / Width	Boy / Height	Derinlik / Depth
KAPAK	190 mm	320 mm	1,5 mm
KASA	155 mm	260 mm	35 mm

STANDART ZAMAK
Serisi / Series

SIVA ÜSTÜ KAT PANELLERİ
Stainless Surface Mounted Floor Panels
الواح طوابق فوق اللباسة من الفولاذ المقاوم للصدأ

İNCE ZAMAK
Serisi / Series

U20SM0004

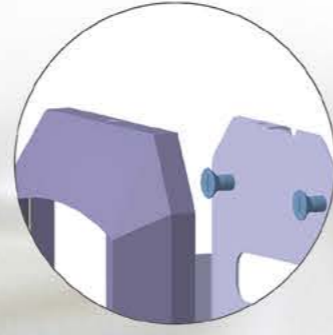

	En / Width	Boy / Height	Derinlik / Deph
U20SM0004	93 mm	260 mm	23 mm
U20SM0005	93 mm	260 mm	23 mm
U20SM0006	93 mm	260 mm	23 mm

U20SM0005

CAM VE PLEKSİGLAS / GLASS PANELS AND PLEXIGLASS



U20SM0006

DOKUNMATİK / TOUCH /



U20SM0003
(İnce Zamak Kablolu)

İnce Model
Slim Model
النموذج ضئيلة



U20SM0018

(İnce Zamak Düz Kablosuz)



	En / Width	Boy / Height	Derinlik / Deph
U20SM0003	85 mm	235 mm	14 mm



U20KU0004
(Truva K.Ü. Gösterge)



U20KU0002
(Kapi Üstü Üçgen)



U20KU0003

U30KU0001
(Kapi Üstü Gösterge Siyah Dokunmatik)

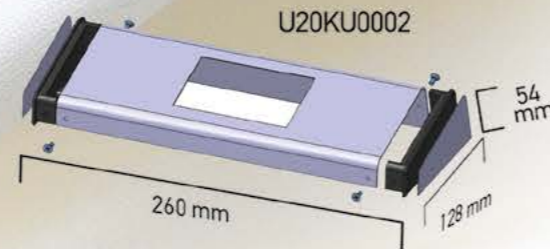

	En / Width	Boy / Height	Derinlik / Depth
U20KU0001	90 mm	240 mm	23 mm
U20KU0002	128 mm	260 mm	54 mm
U20KU0004	75 mm	230 mm	45 mm



U20SM0009
(Tas)

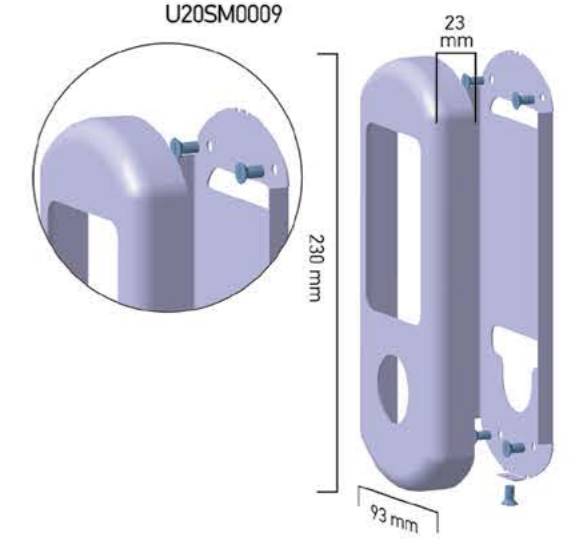

	En / Width	Boy / Height	Derinlik / Depth
U20SM0009	93 mm	230 mm	23 mm
U20SM0007	87 mm	300 mm	23 mm

MONŞARJ
KAT PANELİ



DOKUNMATİK KABİN PANELLERİ
Touch Cabin Panels
لوحة طلب داخلي لمس

U31TM0001
(Tam Boy Kabin Siyah Dokunmatik)

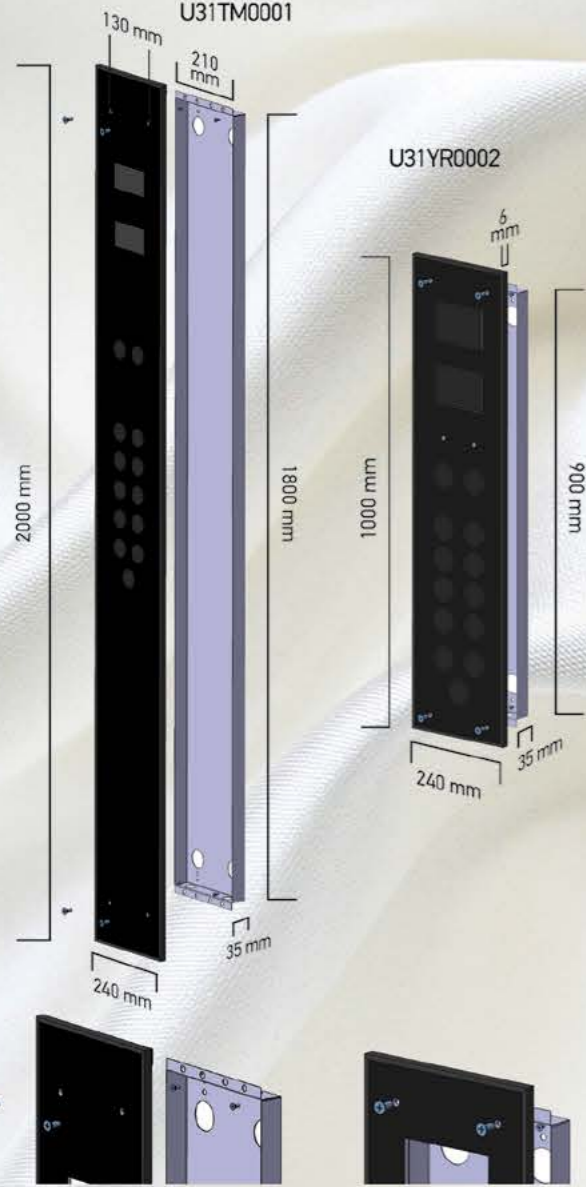

031TM0001	En / Width	Boy / Height	Derinlik / Deph
KAPAK	240 mm	2000 mm	CAM / 6-8 mm
KASA	210 mm	1800 mm	35 mm

031YR0002	En / Width	Boy / Height	Derinlik / Deph
KAPAK	240 mm	1000 mm	CAM / 6-8 mm
KASA	210 mm	900 mm	35 mm

U31YR0002
(Yarım Boy Kabin Beyaz Dokunmatik)



U30KU0001
(Kapı Üstü Gösterge Siyah Dokunmatik)

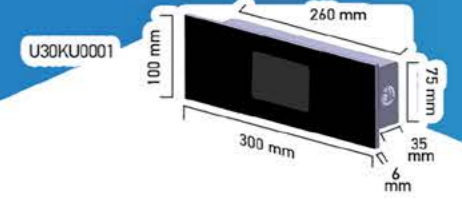

030KU0001	En / Width	Boy / Height	Derinlik / Deph
KAPAK	100 mm	300 mm	6 mm
KASA	75 mm	260 mm	35 mm

U30SM0001
(Simpleks Tek Buton Siyah Dokunmatik)



U30SM0002
(Simpleks Tek Buton Beyaz Dokunmatik)

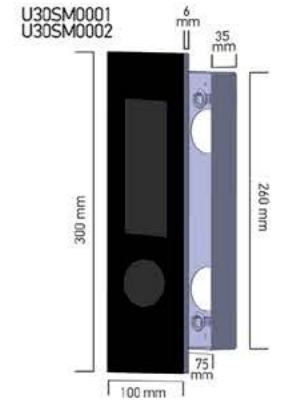

030SM0001 030SM0002	En / Width	Boy / Height	Derinlik / Deph
KAPAK	100 mm	300 mm	6 mm
KASA	75 mm	260 mm	35 mm

U30DJ0002
(Dijitalsiz Çift Buton)



U30DJ0001
(Dijitalsiz Tek Buton)

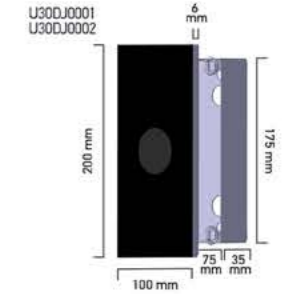

030DJ0001 030DJ0002	En / Width	Boy / Height	Derinlik / Deph
KAPAK	100 mm	200 mm	6 mm
KASA	75 mm	175 mm	35 mm

U30DB0005
(Dupleks Çift Buton Beyaz Dokunmatik)



U30DB0001
(Dupleks Tek Buton Siyah Dokunmatik)

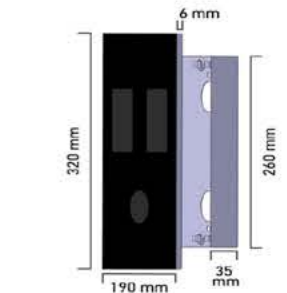

030DB0001 030DB0005	En / Width	Boy / Height	Derinlik / Deph
KAPAK	190 mm	320 mm	6 mm
KASA	153 mm	260 mm	35 mm

U29TM0001
(Tam Boy Kabin Siyah Cam)

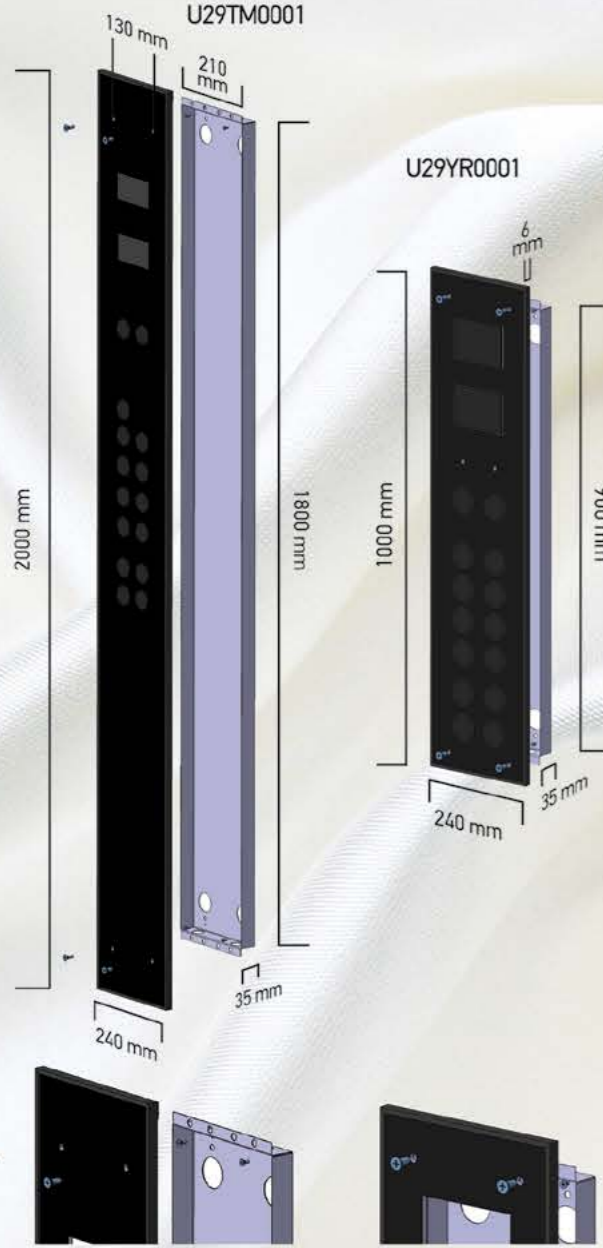

U29TM0001	En / Width	Boy / Height	Derinlik / Deph
KAPAK	240 mm	2000 mm	CAM / 6-8 mm
KASA	210 mm	1800 mm	35 mm
U29YR0001	En / Width	Boy / Height	Derinlik / Deph
KAPAK	240 mm	1000 mm	CAM / 6-8 mm
KASA	210 mm	900 mm	35 mm

U29YR0001
(Yarım Boy Kabin Siyah Cam)



U28SM0001
(Simpleks Tek Buton Siyah Cam)



U28DB0001
(Dubleks Tek Buton Siyah Cam)



U28SM0002
(Simpleks Tek Buton Beyaz Cam)



U28SM0001	En / Width	Boy / Height	Derinlik / Deph
KAPAK	100 mm	300 mm	6 mm
KASA	75 mm	260 mm	35 mm
U28DB0001	En / Width	Boy / Height	Derinlik / Deph
KAPAK	190 mm	320 mm	6 mm
KASA	153 mm	260 mm	35 mm

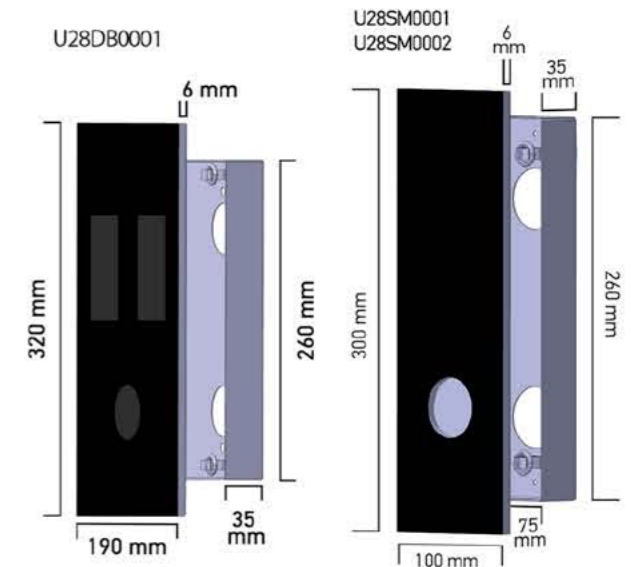

MONTAJ DETAY
FIXATION DETAILS



MONTAJ DETAY
FIXATION DETAILS



ÇİFT YÖNLÜ HABERLEŞME UYGUN

EN
81-70



PRADAS ÇİFT YÖNLÜ HABERLEŞME SİSTEMİ BAĞLANTI ŞEMASI

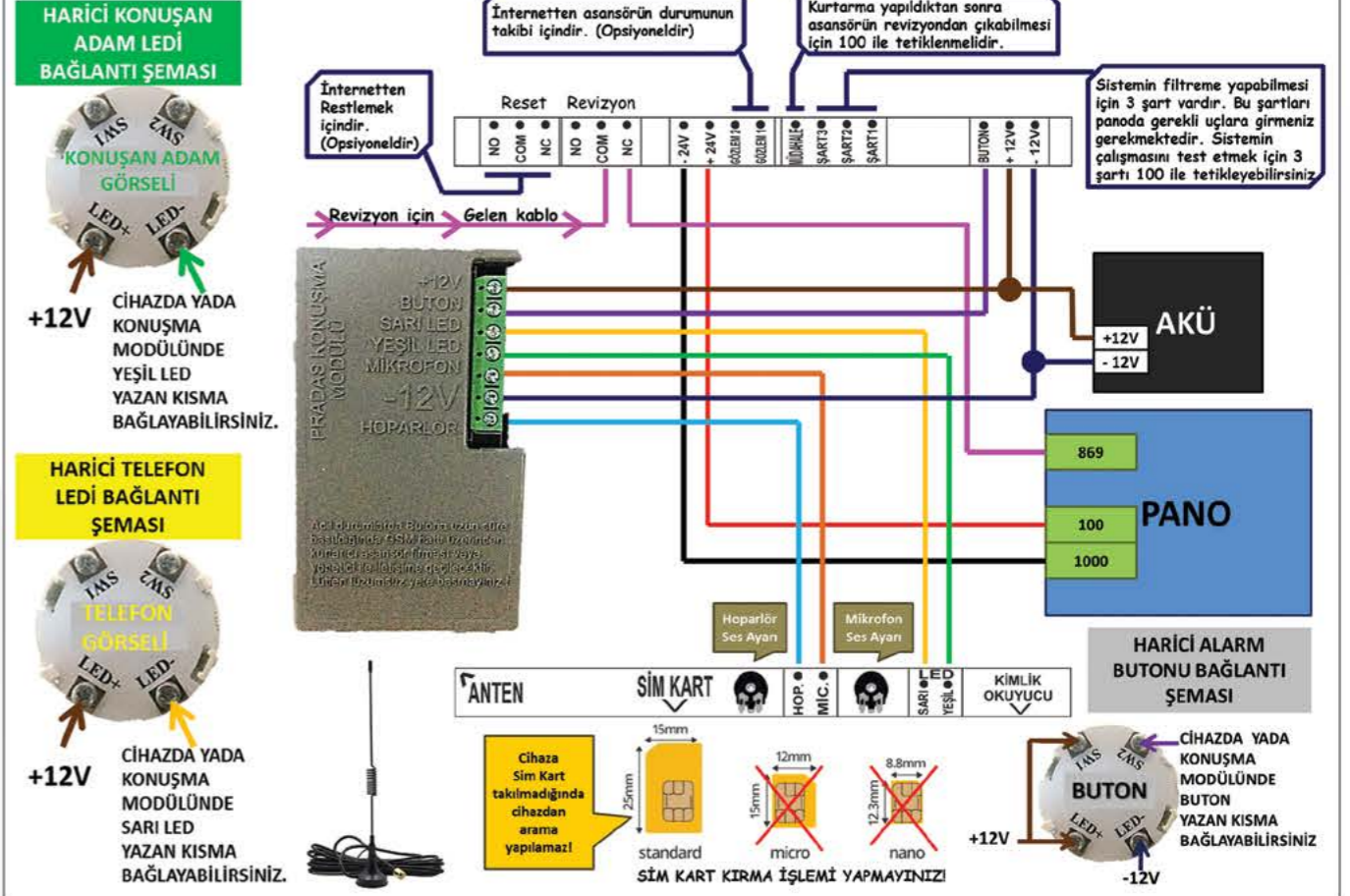

Lvt Test Laboratuvarları Ltd. Şti.
DENEY RAPORU
Test Report

Müşteri: HAKAN SELEK
Adres: ...
Deney Numarası: PRADAS-401
Deney Tarihi: 09.11.2018

Lvt Test Laboratuvarları Ltd. Şti.
Deney Sorumlusu: Tarkan DEMİR
Deney Yapanı: ...

LVT Test Laboratuvarları Ltd. Şti.

Numara	Mıgırlanan Deney	Mıgırlanan Standartlar	Deney Durumu
PRADAS-401	Elektromanyetik Uyumsuzluk Bağlayıcı Deneyi (Immunity Discharge Immunity Test)	TS EN 61000-4-2	...
PRADAS-401	RF Alanlar Yarıldırma Emülasyon Testi (Large immunity test)	TS EN 61000-4-3	...
PRADAS-401	RF Alanlar Yarıldırma Emülasyon Testi (Large immunity test)	TS EN 61000-4-4	...
PRADAS-401	RF Alanlar Yarıldırma Emülasyon Testi (Large immunity test)	TS EN 61000-4-6	...
PRADAS-401	RF Alanlar Yarıldırma Emülasyon Testi (Large immunity test)	TS EN 61000-4-6	...
PRADAS-401	Yayınlanabilirlik Testi (Conducted Emission)	TS EN 55011	...
PRADAS-401	Yayınlanabilirlik Testi (Conducted Emission)	TS EN 55011	...

PRADAS ÇİFT YÖNLÜ HABERLEŞME SİSTEMİNİN GENEL TANITIMI

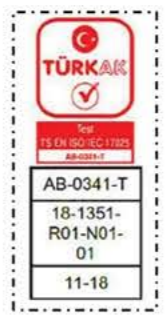
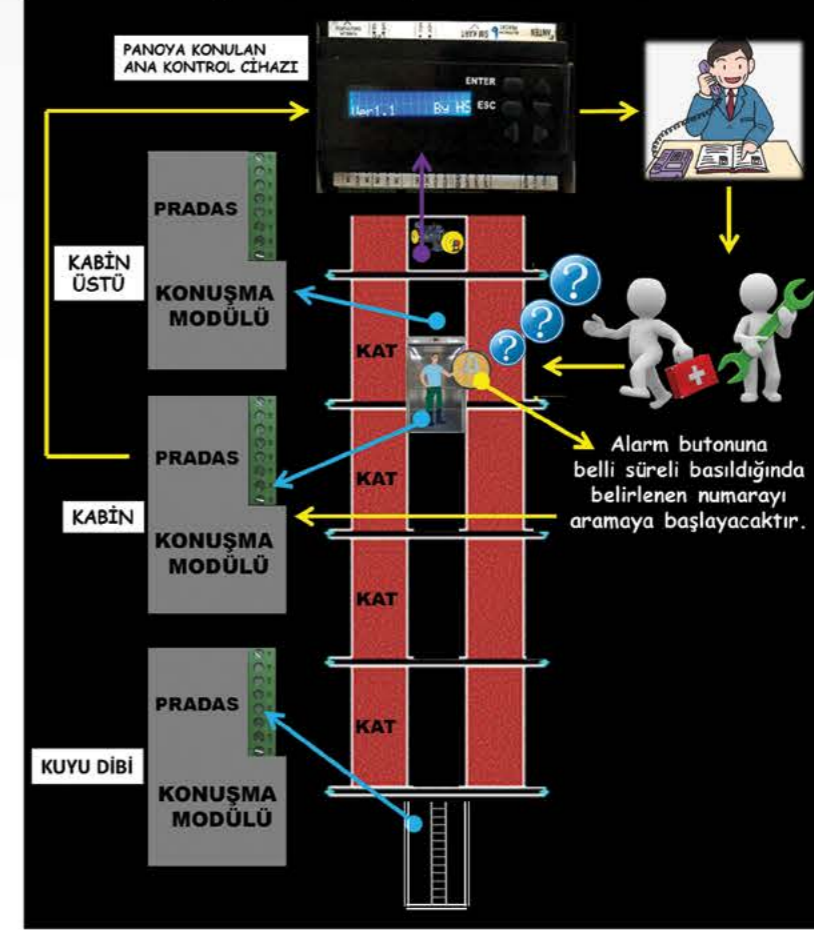

Y11KG0001



Kartlı Geçiş Butonu



T19DG0002



Şifreli Geçiş Butonu

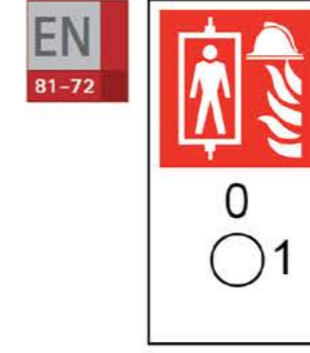

Y11YA0001



Yangın Anahtarı (Ekranlı)



Yangın Anahtarı

Y11TF0001

İnterkom Telefon
(Dört Telli)



Y11TF0002 İnterkom Telefon
(İki Telli)

U20DJ0006



Pradas Sac Panel

Y11AK0001



Akbilli Geçiş Butonu



Satine Süper Ayna Siyah Ayna Sarı Ayna Bronz Ayna



Truva Satine Truva Süper Ayna Truva Siyah Ayna Truva Sarı Ayna Truva Bronz Ayna



HEDEFSAN UYUMLU
HAZIR TESİSAT

MONTAJ DETAY
FIXATION DETAILS

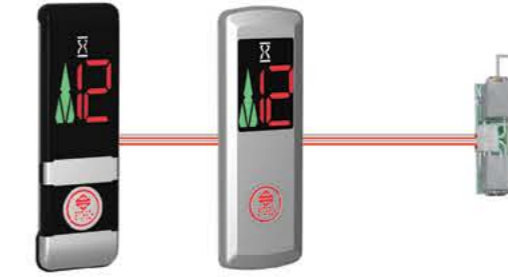

MİKEL UYUMLU
HAZIR TESİSAT

MONTAJ DETAY
FIXATION DETAILS

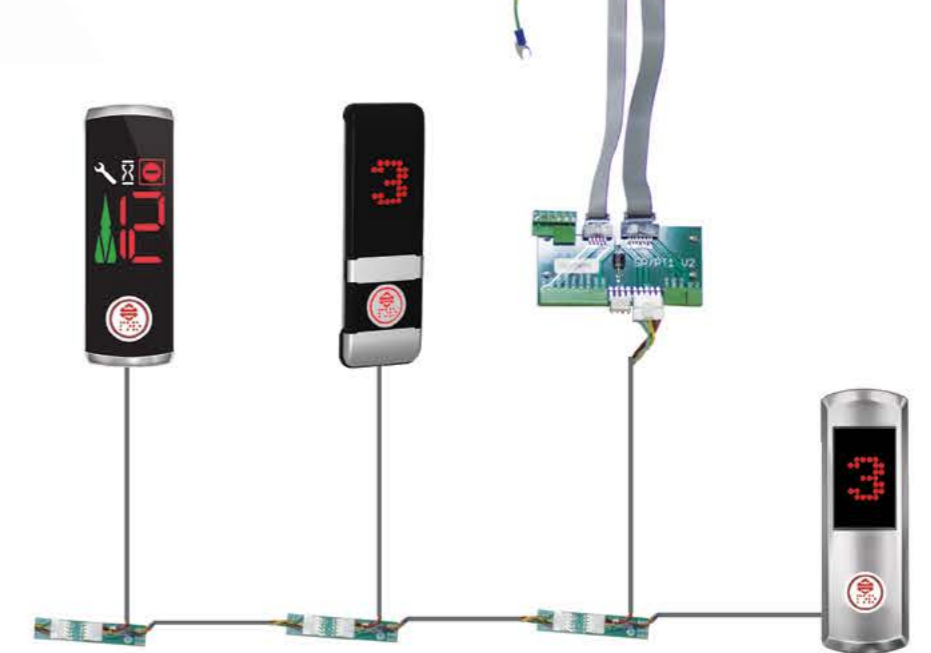

SIVA ALTI BOY PANEL ÖLÇÜLERİ

--	--	--	--	--	--

SIVA ÜSTÜ BOY PANEL ÖLÇÜLERİ

--	--	--	--	--	--

SIVA ALTI YARIM PANEL ÖLÇÜLERİ

--	--	--	--	--	--

SIVA ÜSTÜ YARIM PANEL ÖLÇÜLERİ

--	--	--	--	--	--



BUTKON®



FABRİKA

2. Organize Sanayi Bölgesi Lalehan Cd. No:33

Konya - TÜRKİYE

Tel : +90 (332) 342 66 50 - 52

Fax : +90 (332) 342 51 68

Mail: butkon@butkon.com

ANKARA ŞUBE

Öz Marangozlar San. Sit. 2239/1 Sk. No:5/2

İvedik - Ostim / Ankara - TÜRKİYE

Tel : +90 (312) 394 01 75

Fax : +90 (312) 394 01 76

İSTANBUL ŞUBE

Ferhatpaşa Mah. Mareşal Fevzi Çakmak Cd. No: 111/B

Ataşehir / İstanbul - TÜRKİYE

Tel : +90 (216) 471 80 79